

PLAN MED PARDÖRR

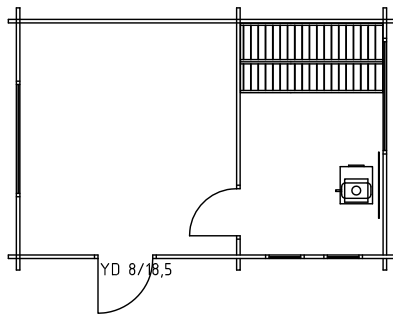

PLAN MED ENKELDÖRR

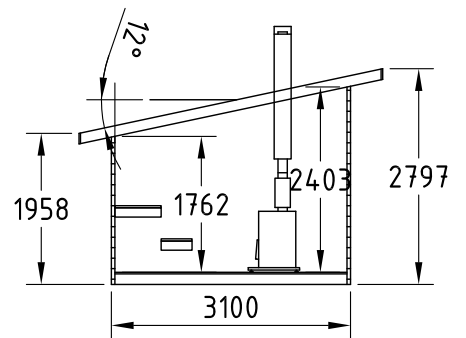

SEKTION

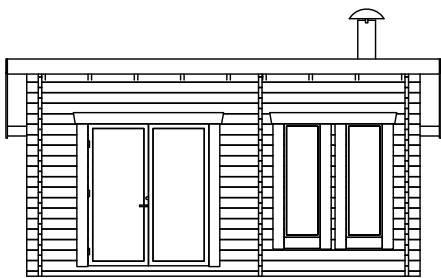

FASAD MED PARDÖRR

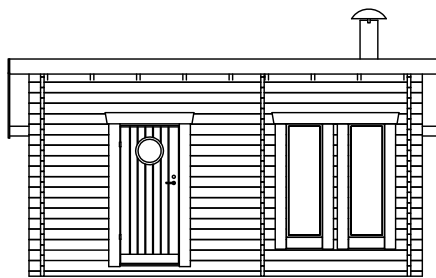

FASAD ENKELDÖRR

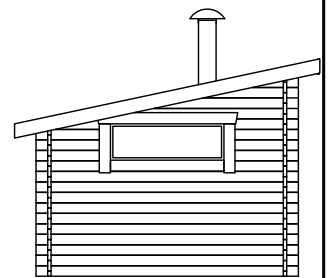

FASAD

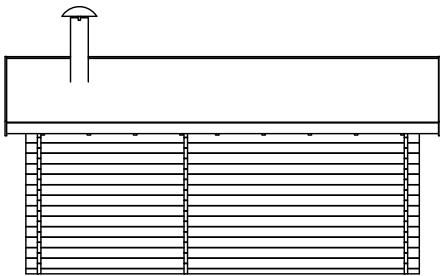

FASAD

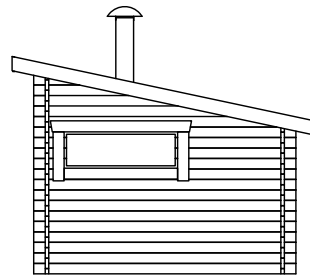

FASAD

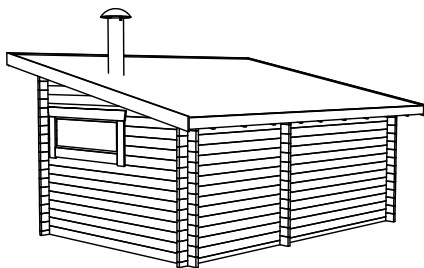

ISO

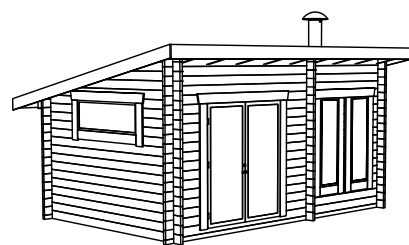

ISO

Ägare



Kotivaara 26  
952 96 LAPPTRÄSK  
E-mail: info@Lhtra.se

Titel/Benämning

BASTU 15 FUNKIS  
Fasad, plan, sektion, iso

Datum

2015-11-10

Ritad

J-EN

Granskad

Skala

1:100

Ritningsnummer