

PLAN

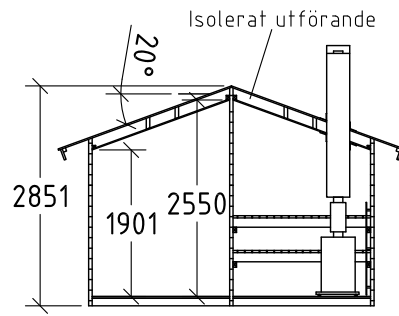

SEKTION

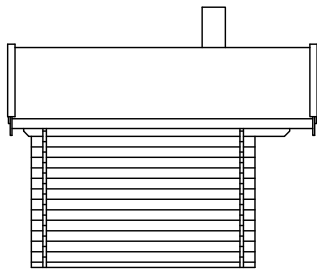

FASAD

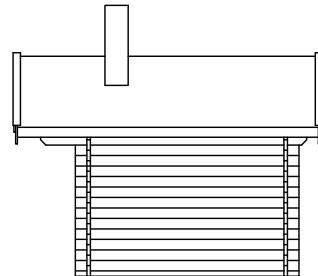

FASAD



FASAD

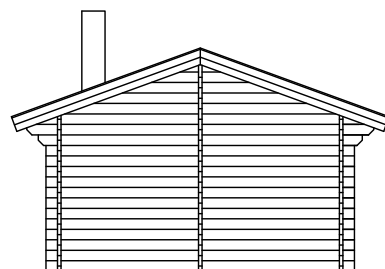

FASAD

Ägare



Kotivaara 26
952 96 LAPPTRÄSK
E-mail: info@Lhtra.se

Titel/Benämning

BASTU 10
Fasad, plan, sektion

Datum

2015-11-10

Ritad

J-EN

Granskad

Skala

1:100

Ritningsnummer